

BIOSWING

Beauty

Kasutusjuhend

HAIDER®

BIOSWING





HAIDER BIOSWING GmbH

Edasimüüja:

Foot Care Center OÜ

Ahtri 6a, Tallinn 10151

+372 5644125

info@footcare.ee

www.jalakaubamaja.ee



eesti | 04 - 11

english | 12 - 19

Õnnitleme Teid uue HAIDER BIOSWINGi puhull!

HAIDER BIOSWING istmesüsteemidel on maailmas ainulaadne tehnoloogia: igas suunas liigutatav ja kontrollitult summutav istmekonstruktsioon, mis peegeldab dünaamiliselt keha energiat.

Teie aju reageerib sellele pidevate mikroimpulssidega Teie asendilihastele. Keha ja vaim saavutavad aktiivse tasakaalu. HAIDER BIOSWING istmesüsteemid suurendavad oluliselt keskendumisvõimet, enesetunnet ja jõudlust.

HAIDER BIOSWING istmemehhanism

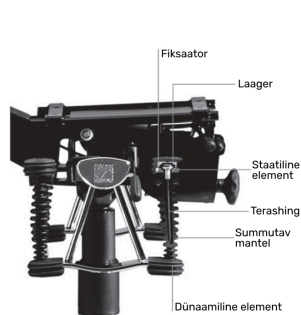

Kõikide seadistusvõimaluste* optimaalseks kasutamiseks lugege palun läbi järgmised kasutusjuhised.

Soovime Teile paremat istumiskogemust Teie uuel HAIDER BIO-SWINGil.

Teie HAIDER BIOSWINGi meeskond

* Reguleerimisvõimalused sõltuvad valitud disainist!

Juhtelementide ülevaade

- 1 Istme kõrgus
- 2 Istme kalde reguleerimine
- 3 Seljatoe kõrguse reguleerimine

- 4 Nimmetugi
- 5 Seljatoe kalle

(Seadistusvalikud olenevalt valitud seadmest!)



1 Istme kõrgus

Reguleerige istmepinna kõrgus vastavalt põlveõndla kõrgusele. Reite ja sääрте vahele moodustub täisnurk või kerge lamenuk. Jalad on täielikult põrandal – avaldamata survet reitele.

Istmepidamine

Istudes tõmmake juhthoob **1** üles ja vabastage see soovitud asendis. Istme alla laskmisel pidage meeles kinnikiilumisohtu aluse ja istme vahelises jalaalas.

Istme kõrgendamine

Vabastage iste, tõmmake juhthoob **1** üles ja vabastage see soovitud asendis.

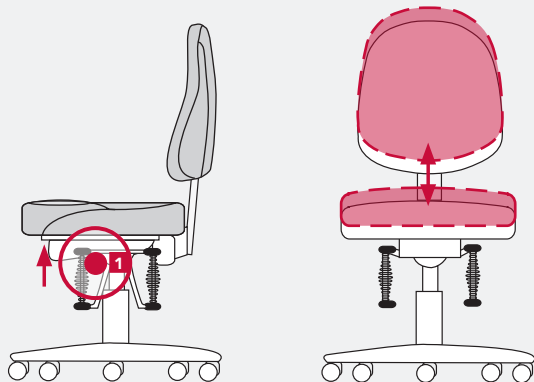

Istme kalde reguleerimine

Füsioloogiliselt õige vaagna kalde toetamiseks saate reguleerida istme mis tahes kaldega. Istme kalle tagab lülisamba soovitud sirgendamise loomulikku topelt-S-kuju.

Reguleerige istme kallet individuaalselt

Istme kaldenurka saab individuaalselt reguleerida, kasutades integreeritud tähtkäepidet **2** istmepadja all, esiosa keskel, keerates seda päri- või vastupäeva.

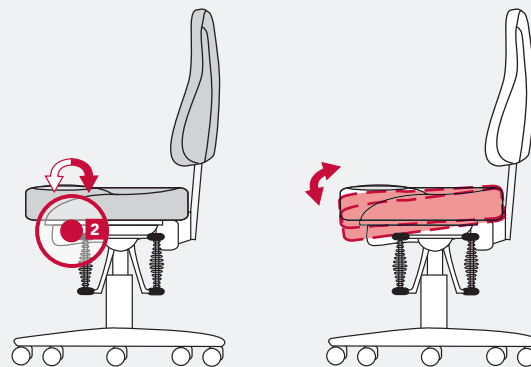

3 Seljatoe kõrguse reguleerimine

Seljatoe kõrgust saate individuaalselt reguleerida vastavalt oma selgroo mõõtmetele. Reguleerige kumerus oma vööga ligikaudu samale kõrgusele, reguleerides seljatoe kõrgust nii, et teie nimmeosa oleks optimaalselt toetatud.

Reguleerige seljatoe kõrgust

Istudes sirutage mõlema käega taha lükake seljatugi **3** sisse. Viige madalaim asend soovitud kõrgusele, lükates seda üles. Pange tähele, et seljatuge saab uuesti alla lasta ainult ülemises asendis.

Nimmetugi

Individuaalselt reguleeritav nimmetugi võimaldab pidevalt reguleerida kumerust nimmepiirkonnas. Reguleerige kumerus oma vööga ligikaudu samale kõrgusele, reguleerides seljatoe **3** kõrgust nii, et Teie alaselg oleks optimaalselt toetatud.

Reguleerige nimmetugi vastavalt selja kontuurile

Kumeruse suurendamiseks keerake seljatoe pöörlevat ratast **4** päripäeva. Vastupäeva pööramine vähendab kumerust

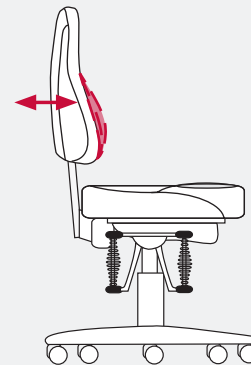
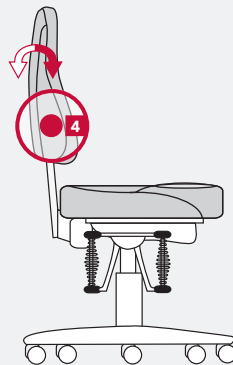
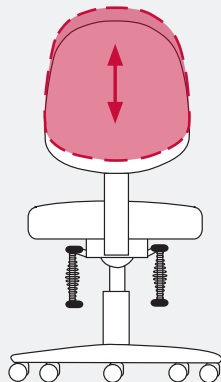
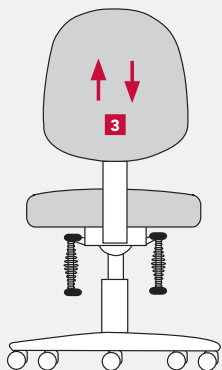

5 Seljatoe kalle

Seljatoe reguleerimine võimaldab Teil pidevalt kallutada. Saate kinnitada seljatoe oma valitud kaldega või reguleerida seljatuge vastavalt oma liigutustele, kasutades püsivat reguleerimist. See julgustab Teid sellel liikumisteljel sageli oma istumisasendit muutama.

Reguleerige seljatoe kallet individuaalselt või püsiva kontaktiga

Tõmmake istudes juhthoobi 5 ülespoole. Seljatugi järgib teie liigutusi. Vabastage hoob ja seljatugi on fikseeritud kaldenurgas. Püsikontakti saate aktiveerida, tõmmates juhthoobi üles ja lükates seda tahapoole.

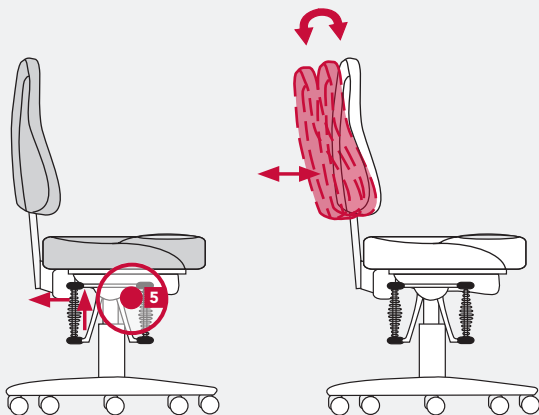

Erijuhised

Kasutage kontori pöördtooli ainult istumiseks. Ärge kunagi seiske toolil!

Gaasivedru

Kõrguse reguleerimise gaasivedru vahetamist ja töid tohivad teha ainult koolitatud spetsialistid. Ärge kuumutage gaasisurvevedrut ega avage seda jõuga.

Rattad

Teie turvalisuse huvides on kontori pöördtool varustatud isepidurdavate ratastega, mis raskendavad koormata liikumist. Põrandakatteid vahetades veenduge, et valiksite õiged rattad.

Pehmetel põrandatel (nt vaibal) kasutamiseks peab tool olema varustatud kõvade ratastega. Kõvad rattad on ühevärvilised. Kõvadel põrandatel (nt parkett, plaadid, linoleum) kasutamiseks peaks tool olema varustatud pehmete ratastega. Pehmed rattad on kahetoonilised, st turvis on teist värvi.

Hooldus

Teie pöörlev tool ei vaja tavakasutuses hooldust. Puhastage värvi-/plast- ja metallpindu pehme käsiharja või lapiga ja pehmetoimeliste pesuvahendite, seepide või rasva lahustavate pesuvahenditega. Olenevalt kasutusest on polstri regulaarne puhastamine/hooldus soovitatav. Kangast katted/mikrokiud tuleb puhastada tolmuimejaga või kaubanduses saadaoleva kuiva vahuga. Nahast või kunstnahast katteid saate hoida elastsena aastaid (päikesevalguse käes), kasutades müügilolevaid hooldustooteid. Plekid tuleb eemaldada niipea kui võimalik. Kuid katsetage enne kohas, mis pole esmapilgul nähtav. Punktpuhastus võib paljastada värvierinevuse võrreldes töötlemata polstrikattega.

Congratulations on your new HAIDER BIOSWING!

HAIDER BIOSWING seating systems come with a globally unique technology: an attenuated seat, which can be moved in all directions, dynamically reflecting the body's energy.

Your brain responds to this by sending constant impulses to your postural muscles. Your body and mind achieve an active equilibrium. HAIDER BIOSWING seating systems significantly increase concentration, well-being and performance.

The HAIDER-BIOSWING seating system.

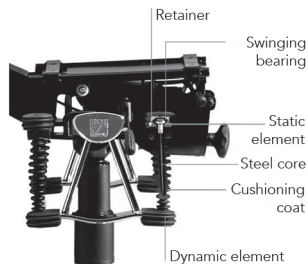

Please read the following instructions in order to be able to use all available settings*.

We wish you an enhanced seating experience on your new HAIDER BIOSWING.

Your HAIDER BIOSWING Team

* Adjustment options depend on the selected design!

Summary of Operating Elements

- 1 Seat height
- 2 Adjusting the seat inclination
- 3 Adjusting the backrest height
- 4 Lumbar support
- 5 Adjusting the backrest inclination

(Adjustment options depend on the selected design!)



Adjusting the seat inclination

To support the physiologically correct tilt of your pelvis, you can incline the seat any way you like. The seat inclination ensures the desired straightening of your spine in its natural double-S shape.

Adjusting the individual seat inclination

You can adjust the seat inclination with the integrated star handle adjuster **2** beneath the front centre of the seat by turning it clockwise or counter-clockwise.

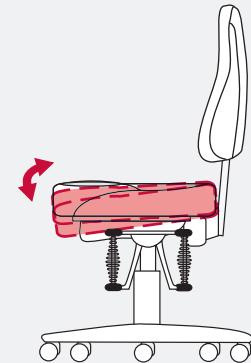

1 Seat Height

Set the height of the seat to the height of the hollows of your knees. Thighs and calves form a 90°, slightly open angle. The feet are flat on the floor – without increased pressure on the thighs.

Moving the seat down

Pull up control lever **1** while seated and let go in the desired position. Caution! Risk of feet getting pinched between the 5-star base and the seating system when lowering the seat!

Moving the seat up

Stand up, pull up control lever **1** and let go in the desired position.

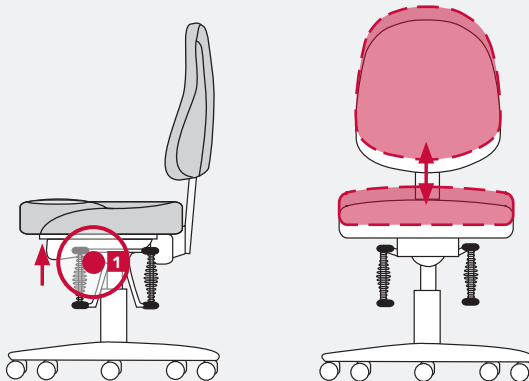

3 Adjustment of Backrest Height

The backrest height can be individually adjusted to the shape of your spinal column.

Adjustment of Backrest Height

While sitting, reach backward with both hands and adjust the backrest **3** to the desired height by pushing it upward from the lowest point. Please note that the backrest can be lowered only from the highest position.

Lumbar Support

The individually adjustable lumbar support allows you to continuously adapt the curvature in the region of your lumbar curve. Adjust the curvature by setting the height of the backrest **3** at approximately the height of your belt to optimally support the lumbar spine.

Adapting the lumbar support to the contour of your back

Turn the wheel **8** on the backrest forward to increase the curvature. If you turn it backward, the curvature decreases.

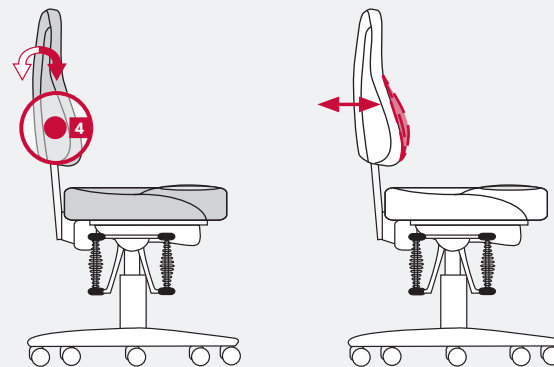
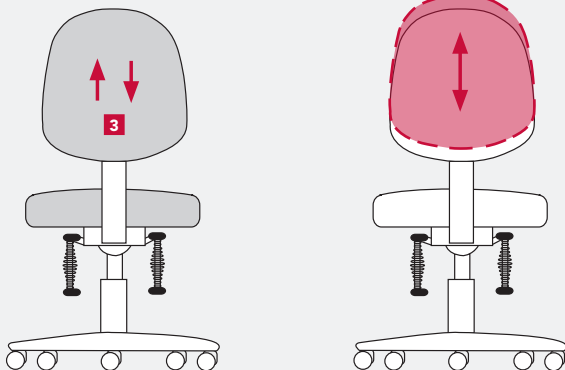

5 Adjusting the backrest inclination

The backrest adjuster allows you to continuously adjust the backrest inclination. You can either fix the backrest in your desired inclination position or adapt the backrest in line with your motion sequences through the permanent adaptation function. This animates you to also frequently change your seating posture in this motion axis.

Adjust the backrest inclination individually or pull it up with the permanent contact handle 5 while seated. The backrest follows your movements. Let go of the lever to fix the inclination of the backrest in place. You can activate permanent contact by pulling the lever up and pressing it backward.

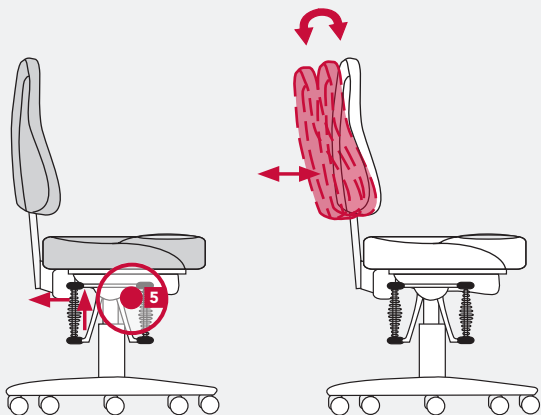

Special Notes

The swivel chair is only intended for sitting. Never climb up on the chair!

Gas Spring

Only instructed personnel may exchange or work with the gas spring (seat height adjustment and backrest inclination adjustment). Do not heat gas springs or pry them open by force.

Castors

For your safety, the swivel chair is equipped with self-braking castors to hinder shifting the chair while not seated. When changing the flooring, make sure you select the right castors.

For use on soft floors (e.g. carpet), the chair should be equipped with hard castors. The hard castors are uni-coloured. For use on hard floors (e.g. parquet, tiles, linoleum), the chair should be equipped with soft castors. The soft castors are bi-coloured, meaning the rolling surface has a different colour.

Maintenance and Care

Your swivel chair is maintenance-free when used normally. Clean lacquered/plastic and metal surfaces with a soft hand brush or cloth and mild detergent, soaps or fat-soluble detergent. Depending on use, we recommend regular cleaning/maintenance of the upholstery. Clean fabric covers/micro-fiber covers by hoovering or with conventional dry foam. Leather or faux leather covers will stay supple for many years (solar radiation) when treated with conventional care products. Remove stains as soon as possible. However, first perform a test on an invisible spot. Cleaning individual stains may result in a colour difference to the untreated part of the upholstery.